

E-Z-ON[®] School Bus Catalog



E-Z-ON Products, Inc. of Florida
1-800-323-6598 • Fax 561-747-8779
www.ezonpro.com

For decades E-Z-ON® has been the respected leader in the school bus transportation industry providing children and adults with safety, support, and security.

Safety System

E-Z-ON® Vests are dynamically crash tested to meet and exceed Federal Motor Vehicle Safety Standards 213.

Support System

E-Z-ON® Vest provides support, keeping the passenger upright and secure. E-Z-ON® Vests are secured with E-Z-ON® Mounts and are tested to restrain children and adults up to 168 lbs.

Security Restraint System

E-Z-ON® Vests are recommended #1 by professionals for children and adults with behavioral, emotional and physical disabilities.

Safe Pupil Transport for All Children

E-Z-ON® was the very first to design, test and successfully market the "Vest," with the (CamWrap™) "Seat Mount System" – the most popular, portable and safest way to secure children on school buses today!

***E-Z-ON Is Proud
to Say...
Made in the USA!***

E-Z-ON®

Products, Inc. of Florida

605 Commerce Way West • Jupiter, FL 33458

800-323-6598 • Fax 561-747-8779 • www.ezonpro.com

Table of Contents

E-Z-ON® Products for School Buses

Adjustable Vests and Mounts

103 Vest	2
Vest Mounts	3
203 Vest.....	4

Non-adjustable Vests

Push Button Vest	5
Zipper Vest	6

Vest Size and Closure Information

Vest Sizes and Back Closures for School Buses	7
Vest Sizes and Front Closures for School Buses	8

Mounting Straps

School Bus Seat Mount	9
School Bus Tether Mount	10
School Bus Floor Mount	11
Wheelchair Mounting Strap	12

Harnesses

1086 CamHarness	13
543 KidCam™ Harness	14

Ordering

Distributor List	15-18
------------------------	-------

E-Z-ON® Adjustable 103Z Vest for School Buses

The Complete Adjustable Vest that Grows with the Passenger!



Model #103Z

- XXS-M Vests have sewn crotch straps that meet NHTSA guidelines
- Portable or sewn crotch straps are available.
- Meets FMVSS 213
- Must use with E-Z-ON®'s seat mount, bus tether mount, floor mount, or wheelchair mount
- Fits ages 2-Adult 20-168 lbs.
- Accessories are available
- Replace after crash or 5 years from the date of manufacture
- U.S. Pat. #5,733,014

See page 8 for ordering information

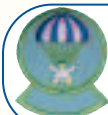

The Parachute logo will always be visible on the front of every E-Z-ON® Vest



SLIM ADJUSTER COVERS



front



back

- Adjustable shoulder straps pull easily to lengthen and shorten the vest for a secure fit. The hip strap must remain low around the lap.
- Bar slides keep busy fingers from undoing shoulder straps. Shoulder straps back-thread and lock.
- D-rings make securement a snap when using the E-Z-ON® Seat Mount, Floor Mount in school buses.
- Adjustable Zipper Panel

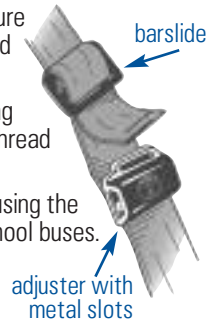

Quick and Easy!

- E-Z-ON® Vests can be comfortably fitted before getting in the school bus.
- No-more struggling on the bus with restraints!
- Simple and secure mounting straps make attachment to the vest a snap, for school bus and wheelchairs.
- Wash with mild soap and hang dry.

Adjustable Zipper Panel

Sewn-zipper panel offers 3 zipper sizes to adjust chest and waist straps. Perfect for growth spurts and bulky clothing. Made for children and adults 20-168 lbs.

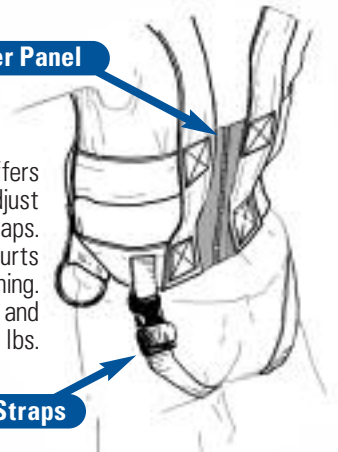

Crotch Straps

**LAP BELT REQUIRED:
Adjustable 103Z Vest
with E-Z-ON® Tether Mount**

With a booster no crotch straps are needed to meet FMVSS213

Bus tether hardware: 7/16" bolt, 1" washer, tether bracket (swivel), nut. (Available to order)



School Bus Seat Mount

E-Z-ON® hooks attach to vest D-rings for fast and safe securement.

No hardware or seat belts needed.



**E-Z-ON®
103Z Vest**

**LAP BELT NOT REQUIRED:
Adjustable 203 Vest with Seat Mount**

E-Z-ON® hooks attach to metal slots on an adjustable vest at the shoulders, and attach to D-rings on the hip strap.

XS-S Vests have sewn crotch straps that meet NHTSA guidelines.

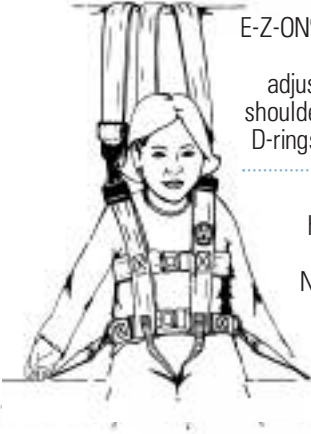

**E-Z-ON®
hook**

E-Z-ON® hooks attach to hip D-rings and/or metal slots for the E-Z-ON® Seat Mount. Snap hooks attach to hip D-rings for the Floor Mount and E-Z-ON® Wheelchair Mount.

LAP BELT NOT REQUIRED:

E-Z-ON® Bus Floor Mount



School Bus Seat



**D-ring with
snap hook**



E-Z-ON® Wheelchair Mount

Use only as a passenger restraint with an E-Z-ON® Vest. This is not a securement for the wheelchair.

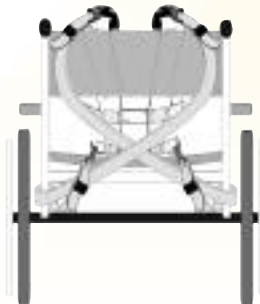

**Mounts
for E-Z-ON®
Adjustable Vests
used in
School Buses**

E-Z-ON® Adjustable 203 Vest for School Buses



SLIM ADJUSTER COVERS

The Push Button Adjustable Vest

Mini-Push Buttons adjust with fast connect and easy release.

Adjustable shoulders straps can lengthen and shorten the vest for a secure fit. The hip strap must remain low around the lap.

Bar slides keep busy fingers from adjusting the shoulder straps. Shoulder straps back-thread and lock.



Hooks attach to metal slots on the adjustable 203 vest at the shoulder.

Model #203

- XS-S Vests have sewn crotch straps that meet NHTSA guidelines
- Meets FMVSS 213
- Must use with E-Z-ON's seat mount, tether mount, floor mount, or wheelchair mount
- Fits ages 2 & up 20-65 lbs.
- Accessories are available
- Replace after crash or 5 years from the date of manufacture
- U.S. Pat. #4,226,474

See page 9 for ordering information



The Parachute logo will always be visible on the front of every E-Z-ON® Vest



Crotch straps must be threaded correctly to lock.



E-Z-ON® 101PB Vest for School Buses



The Front Closure Push Button Vest



- Push Button closures offer a quick connect and simple release. Easy to adjust chest and waist straps for a secure fit. The Mini-Push button (XS-S) vests are ideal for smaller children 20-65 lbs. Standard push button vests are designed for larger children and adults up to 168 lbs.
- Crotch Straps come standard on mini-push button XS-Small vests, meeting NHTSA requirements for FMVSS213.

XS-S Vests Mini-Push Button



S-M Vests Standard Push Button

Model #101/102 PB

- XXS-M Vests have sewn crotch straps that meet NHTSA guidelines
- Meets FMVSS 213
- Must use with E-Z-ON®'s school bus tether mount, floor mount, or wheelchair mount
- Fits ages 2 and up 20-65 lbs.
- M-XXLG Vest up to 168 lbs.
- Accessories are available
- Replace after crash or 5 years from the date of manufacture
- U.S. Pat. #4,226,474

See page 9 for ordering information

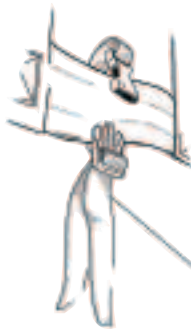

D-rings make securing a snap when using the E-Z-ON® Floor Mount or Tether Mount, in school buses.



back view of portable crotch straps



portable crotch straps

snap on here

Portable or permanent crotch straps are also available for larger sizes when ordering.



The Parachute logo will always be visible on the front of every E-Z-ON® Vest

E-Z-ON® Zipper Vest for School Buses

The Zipper Non-Adjustable Vest

The Zipper vest is desirable for passengers who need extra restraint and discouragement from releasing closures. Back zipper is fast and easy to secure.

Crotch straps are standard only on XS-M vests. Portable or permanent crotch straps are also available for larger size vests when ordering.

D-rings make securing a snap when using the E-Z-ON® Floor Mount or Seat Mount in school buses.



Model #101

- XS-M Vests have sewn crotch straps that meet NHTSA guidelines
- Meets FMVSS 213
- Must use with E-Z-ON®'s seat mount, floor mount or wheelchair mount
- Fits ages 2-Adult 20-168 lbs.
- Accessories are available
- Replace after crash or 5 years from the date of manufacture
- U.S. Pat. #4,226,474

See page 8 for ordering information

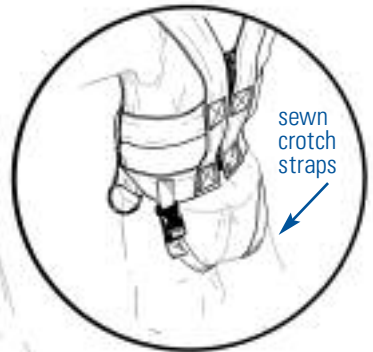

XS-S-M Vests have permanent crotch straps that meet FMVSS213.



The Parachute logo will always be visible on the front of every E-Z-ON® Vest

E-Z-ON®
hook



Vest Sizes and Back Closures for School Buses

Model #103Z

Adjustable shoulders
Adjustable 3 zipper body panel
2 Hip D-rings
20-168 lbs.

Size	Age	Waist
XXS	2-4	19-23"
S	4-6	25-30"
M	8-14	32-37"
LG	14-adult	37-42"



Crotch straps are standard
XXS-M only
M/LG vests are burgundy
LG are black vests

Choose Correct Size When Ordering

E-Z-ON® VEST w/Floor Mount103ZFM
E-Z-ON® VEST w/Seat Mount103ZS
E-Z-ON® VEST w/Wheelchair Mount103ZWC
Tether Mounts Available – See Page 11

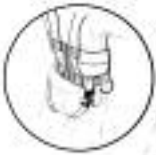

Model #101

Non-adjustable shoulders
Non-adjustable body
1 Zipper
2 Hip D-rings

Size	Age	Waist
XS	2-4	22"
S	4-6	25"
S/M	6-8	28"
M	14-adult	32"

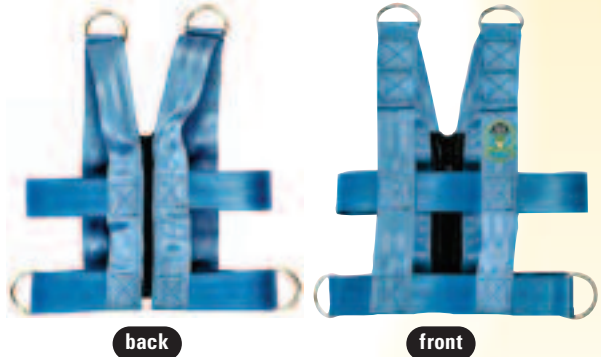

Adult #102 series

M/LG	34"	XLG 40"
LG	37"	XXLG 43"

Crotch straps are standard
XS-M only

Choose Correct Size When Ordering

Children's sizes
E-Z-ON® VEST w/Floor Mount101FM
E-Z-ON® VEST w/Seat Mount.....101S
E-Z-ON® VEST w/Wheelchair Mount101WC

Adult sizes
E-Z-ON® VEST w/Floor Mount102FM
E-Z-ON® VEST w/Seat Mount102S
E-Z-ON® VEST w/Wheelchair Mount.....102WC
Tether Mounts Available – See Page 11

Vest Sizes and Front Closures

for School Buses

Model #203

- Adjustable shoulders
- 2 Mini-Push Buttons
- 2 Hip D-rings
- Crotch Straps

Size	Age	Waist
XS	2-4	18-22"
S	4-6	22-25"

Choose Correct Size When Ordering

- E-Z-ON® VEST w/Floor Mount203FM
- E-Z-ON® VEST w/Seat Mount203S
- E-Z-ON® VEST w/Wheelchair Mount203WC
- Tether Mounts Available – See Page 11



Model #101PB (XS-S)

- Non-adjustable shoulders
- 2 Mini-Push Buttons
- 2 Hip D-rings
- Crotch Straps

Size	Age	Waist
XS (mini- pb)	2-4	22-25"
S (mini- pb)	4-6	25-28"

Choose Correct Size When Ordering

- Children sizes
- E-Z-ON® VEST w/Floor Mount101FMPB
- E-Z-ON® VEST w/Seat Mount101SPB
- E-Z-ON® VEST w/Wheelchair Mount101WCPB
- Tether Mounts Available – See Page 11

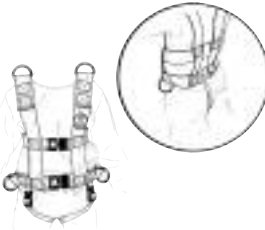

Model #101 PB/102 PB

- Non-adjustable shoulders
- 2 Hip D-rings
- 2 Standard Push Buttons

101PB (S-M)			102PB (M/LG-XXLG)			
Size	Age	Waist	Size	Waist	Size	Waist
S/M	6-8	28-32"	M/LG	34-37"	XLG	40-43"
M	14-adult	32-34"	LG	37-40"	XXLG	43-46"

Choose Correct Size When Ordering

- Children sizes
- E-Z-ON® VEST w/Floor Mount101FMPB
- E-Z-ON® VEST w/Seat Mount101SPB
- E-Z-ON® VEST w/Wheelchair Mount101WCPB
- Adult sizes
- E-Z-ON® VEST w/Floor Mount102FMPB
- E-Z-ON® VEST w/Seat Mount102SPB
- E-Z-ON® VEST w/Wheelchair Mount102WCPB
- Tether Mounts Available – See Page 11



Portable or permanent crotch straps available to order

E-Z-ON® Seat Mount (CamWrap™) for School Buses

E-Z-ON® Seat Mount is portable and needs no seat belts to meet FMVSS213

Easy to install. Just wrap mount securely around bus seat, adjust hooks snugly to the vest and away you go!

No fussing with complicated installation! Secures passengers 20-168 lbs. age 2-Adult.

E-Z-ON® hooks prevent busy fingers from unlatching. Seat Mount secures easily to either vest D-rings on adjustable vest or metal slots.

The E-Z-ON® portable Seat Mount easily secures 3 passengers to a standard bus seat!



E-Z-ON® hook

- NHTSA recommends that passengers behind occupants in Seat Mount be restrained with a seat belt or other restraint or the seat be unoccupied.
- Push button closure faces the seat back to prevent busy-fingers unlatching!
- FMVSS213 approved.

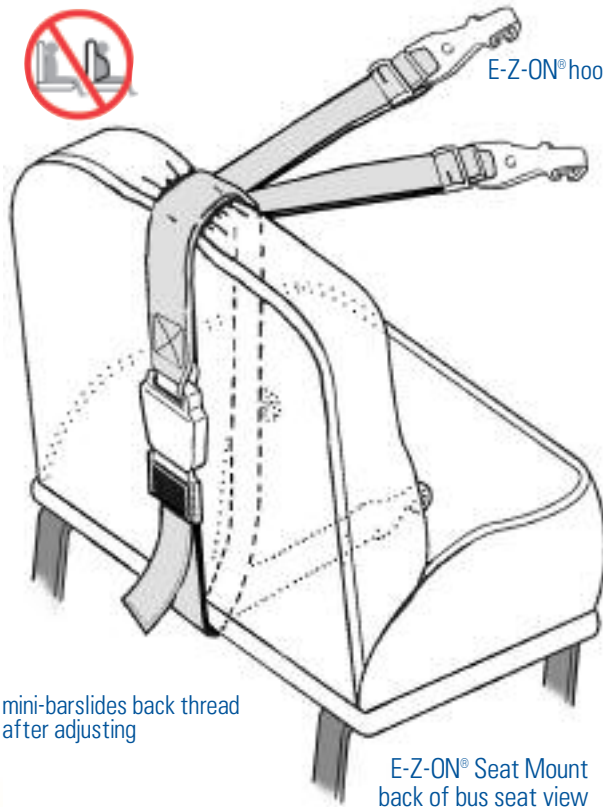

mini-barslides back thread after adjusting

E-Z-ON® Seat Mount
back of bus seat view



E-Z-ON® Seat Mount

E-Z-ON® Bus Tether Mount for School Buses

LAP BELT REQUIRED:

The E-Z-ON® Bus Tether Mount is required for any E-Z-ON® vest on school bus seats with seat belts.

Thread the lap belt through the E-Z-ON® vest belt loops. Snap hooks are attached to the vest. The tether hook attaches to the bus tether anchor.

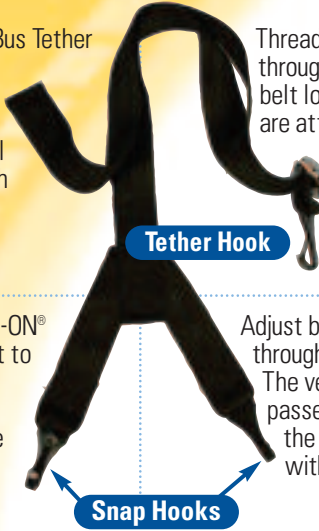

Install the E-Z-ON® tether bracket to the existing seat belt hardware. See picture below.

Adjust by pulling the web end through the tilt-lock adjuster. The vest should fit the passenger snug and the tether adjusted without slack.



- The E-Z-ON® Bus Tether Mount can secure passengers weighing 20-168 lbs.. Use the E-Z-ON® tether bracket to anchor to the bus frame up to 168 lbs.
- Snap hooks simply clip on to the vest shoulder D-rings or metal slots on adjustable vests.
- A vehicle belt **MUST** be used with the E-Z-ON® Bus Tether Mount. The E-Z-ON® Bus Tether Mount secures the upper body.
- The lap belt secures the lower body.



Tether bracket (swivel) included



Lift up on tilt-lock to adjust tether

Tether attaches under bus seat, using seat belt hardware or E-Z-ON® hardware

E-Z-ON® Floor Mount for School Buses

The E-Z-On® Vest Must Be Used

- This E-Z-ON® Floor Mount is the perfect design that safely restrains children with the E-Z-ON® Vest in school buses.
- The E-Z-ON® Floor Mount should be used for passengers with emotional or behavioral disorders who need additional restraint.
- Children who unbuckle their car seats or seat belts can endanger themselves and distract the bus driver.
- The E-Z-ON® Floor Mount used with the E-Z-ON® Vest creates a safe and secure restraint that exceeds a typical seat belt or 5 pt. car seat.

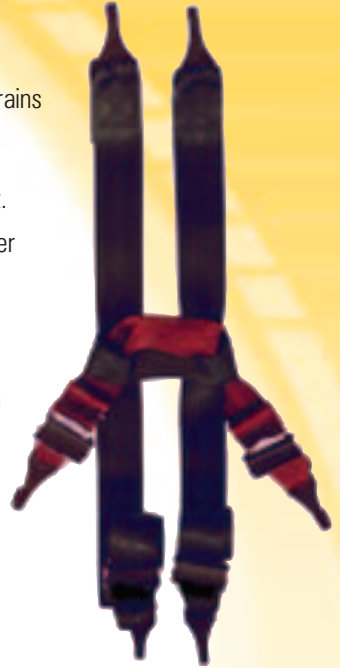
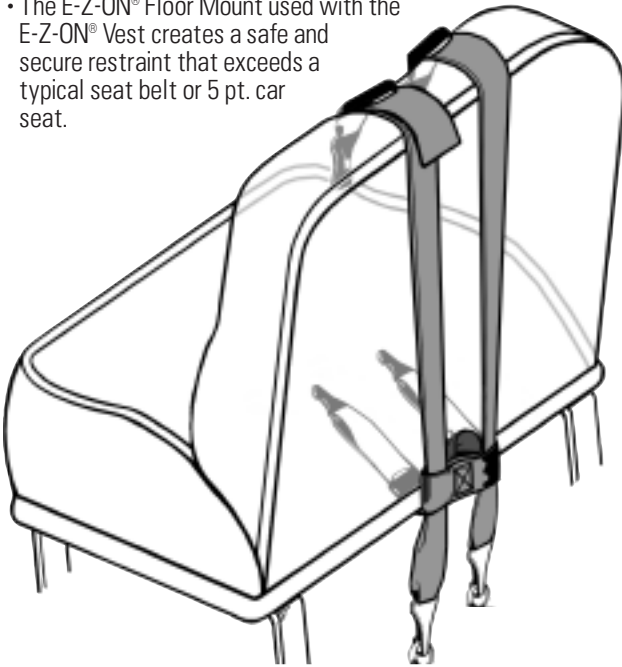

lift up on tilt-lock
to adjust tether

This product must be used on school bus seats that let the snap hook pass through the seat and attach to the passenger.

Hardware kit included. E-Z-ON® Floor Mount secures passengers 20-168 lbs. safely without the need of a vehicle seat belt.



Use only with
E-Z-ON® Vests.

Slim tilt-locks makes
adjustments easy for all
connecting straps.

7/16" bolt
2" washer
tether bracket (swivel)
nut
2 sets come with the
E-Z-ON® Floor Mount

E-Z-ON® Wheelchair Mount for School Buses

E-Z-ON® Wheelchair mount now with velcro!

Securing the E-Z-ON® Vest with passenger to a wheelchair is now easier than ever, with the new E-Z-ON® Wheelchair Mount.

The E-Z-ON® Wheelchair mount is designed to secure the passenger in the E-Z-ON® vest. Adaptable to any size wheelchair!

Tilt-lock adjusters make shortening and lengthening the mount straps easy!



Back view of wheelchair with New E-Z-ON® Wheelchair Mount

- Straps are easily shortened or lengthened with the Tilt-lock adjuster!
- Cross the 2 webbing straps and wrap above both cross bars. Snap hooks easily attach to the vest at the shoulders and the hip straps. Reduce slack in web straps and your passenger is ready to ride!
- It is necessary to use approved tie downs and not the E-Z-ON® Wheelchair Mount to secure the wheelchair on the school bus.

Approved tie downs are required to secure the wheelchair. The E-Z-ON® Wheelchair Mount secures the Passenger.

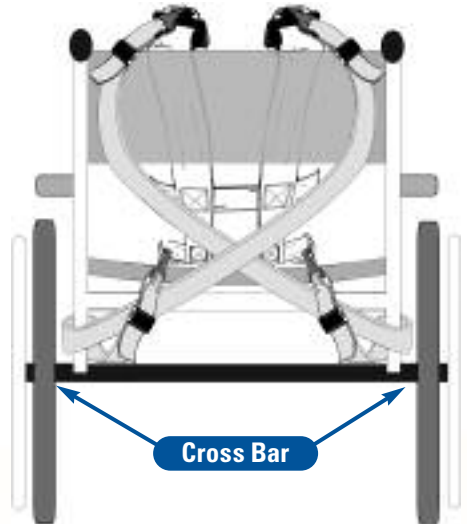

E-Z-ON® 1086 CamHarness™ for School Buses



Patent Pending



Tilt lock adjusters makes it easy to fit any size.



- This design combines the safety of a full harness with the convenience of a portable restraint that children and school bus drivers love!
- Safely transports passengers 30-80 lbs. on school bus seats.
- Tested and certified to meet NHTSA FMVSS213 standards up to 65 Lbs.
- E-Z-ON® CamHarness helps school buses transport at full capacity, fitting 3 passengers to a seat!
- No hardware installation necessary.
- The CamHarness secures around a bus seat equipped with standard lap-belts. The Lap-belt threads through the loops on the CamHarness to secure the passenger.
- Using a booster with the 1086 eliminates the need for crotch straps according to NHTSA guidelines.
- Chest clip included, perfect for smaller

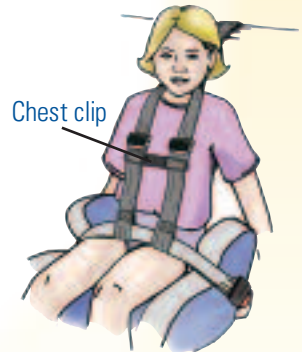

Passengers must use existing crotch straps to meet NHTSA guidelines.



NHTSA recommends that passengers seated directly behind occupants in CamHarnesses be restrained with a seat belt or other restraint or the seat be unoccupied.

E-Z-ON® 543 KidCam™ Harness



This NEW design safely transports children 30-80 lbs. on school bus seats. E-Z-ON® KidCam™ fits 3 to a seat.

The KidCam™ Harness secures around a bus seat equipped with standard lap-belts.

Installs without hardware. This KidCam™ Harness has 1.5 webbing and fits preschoolers perfectly and adjusts to each growing height!



The lap-belt threads through the loops on the KidCam™ Harness to secure the passenger. The 2 piece chest clip keeps the shoulder straps in place.



Clip latch makes installation a snap!

Tested and certified to meet NHTSA FMVSS213 standards up to 65 lbs.



Spring adjusters make it easy to adjust for adults yet protective for kids! Velcro tabs keep web ends secure.

Velcro Tab



- Using a KidCam™ Harness with a booster eliminates the need for crotch straps.
- NHTSA recommends that passengers seated directly behind occupants in seat mounted Harnesses be restrained with a seat belt or other restraint or the seat be unoccupied.



Distributors of E-Z-ON® Products, Inc. of Florida

ALABAMA

Transportation South
1400 McCain Parkway
Pelham, AL 35124
205-663-2287
800-367-9463
205-663-2378 fax
www.transportationsouth.com
phillipwaters@transportationsouth.com

ALASKA

Quality Equipment Sales & Service
11801 S. Gambell Street
Anchorage, AK 99515
907-349-6215
907-349-2232 fax
quality@ak.net

ARIZONA

DLD Truck Straps
3068 N. 30th Drive
Phoenix, AZ 85017
888-862-2878
602-278-4727 fax
Kathy@dldtruckstraps.com
www.dldtruckstraps.com

CALIFORNIA

A-Z Bus Sales
P.O. Box 700
Colton, CA 92324
800-437-5522
951-684-8031 fax
www.a-zbus.com
jpederson@a-zbus.com

A-Z Bus Sales
3418 52nd Avenue
Sacramento, CA 95823
800-635-7491
916-391-1093

COLORADO

Colorado West Equipment Inc.
7920 East 88th Avenue
Henderson, CO 80640
303-288-1300
303-288-2402 fax
bus@cowest.net

CONNECTICUT

Dattco Inc.
583 South Street
New Britain, CT 06051
800-229-4879 Ext. 711
860-826-1115
www.dattco.com
doug@dattco.com

FLORIDA

Action Mobility
1925 10th Avenue North
Lake Worth, FL 33461
800-432-1459
561-582-2921 fax
www.actionmobilityproducts.com
jlockwood@actionmobilityproducts.com

Florida Transportation
7703 Industrial Lane
Tampa, FL 33617
800-282-8617
813-985-7874 fax
www.fts4buses.com
tlukens@fts4buses.com

1st Class Coach
88 East Broad Street
Winter Garden, FL 34787
800-330-1175
407-656-9242 fax
www.1stclasscoach.com
glen@1stclasscoach.com

GEORGIA

Bickel Truck & Equipment
116 Carroll Street
Thomasville, GA 37192
229-226-1565
229-226-4710 fax
gretchen@rose.net

National Sales & Service
P.O. Box 6549
Marietta, GA 30065
800-282-7981
770-422-7721 fax
www.nationalbussales.com
jswim@nationalbussales.com

GEORGIA (cont)

School Specialty
1 Sportime Way
Atlanta, GA 30340
770-449-5700
800-845-1535 fax
www.sportime.com
bid.requested@sportime.com

HAWAII

Hawaiian Islands Med. Corp.
841 Pohukaina Street #8
Honolulu, HI 96813
808-597-8474
808-597-8087
www.himed.cc

ILLINOIS

Denman Services
1014 Main Street
Quincy, IL 62306
217-223-3121
217-223-3305 fax
www.denserve.com
ejones@blessinghospital.com

Midwest Transit Equipment Inc.
1336 W. New Monee Road
Crete, IL 60417
877-813-5970
708-672-3939 fax
www.midwesttransit.com

IOWA

Brower School Bus
122 N. Elm Avenue
Ames, IA 50010
800-338-7081
515-233-0828 fax
browsersbp@aol.com

School Bus Sales
4537 Texas Street
Waterloo, IA 50704
800-772-2414
319-296-3023 fax
www.sbsales.com
sbs@forbin.net

INDIANA

Mid West Transit Equipment
4500 S. Indianapolis Road
Whitestown, IN 46075
317-769-2546
317-769-2548 fax
www.midwesttransit.com

KANSAS

Double B Distributing
P.O. Box 6052
Leawood, KS 66206
913-341-0615
913-341-0619 fax
vreichle@aol.com

KENTUCKY

Ridgeway Distributors
3310 Ruckriegel Parkway
Louisville, KY 40299
502-491-5052
800-626-2208
503-287-5690 fax
www.ridgewaydist.com
ridgewaydist@aol.com

LOUISIANA

D&L Industrial Sales & Trading
P.O. Box 73005
1939 Hickory Avenue Suite 202
Harahan, LA 70123
504-818-1096
504-818-1098 fax
sales@industrialeqpt.com

MASSACHUSETTS

Dattco Inc.
583 South Street
New Britain, CT 06051
800-229-4879 Ext. 711
860-826-1115
www.dattco.com
doug@dattco.com

MICHIGAN

Hoekstra Truck
3741 Roger B. Chafee Blvd. S.E.
Grand Rapids, MI 49548
800-444-4104
616-241-1111 fax
www.hoekstratruck.com
rtrimm@hoekstratruck.com

Unity School Bus
6221 King Road
Marine City, MI 48039
800-937-3906
810-765-2835 fax
www.unityparts.com

Prevention Alternatives
2047 Lac Dumont
Haslett, MI 48840
517-927-7731
517-913-5999 fax
stores.ebay.com/safetyproductsforfamilies
shinn@comcast.net

MINNESOTA

Grande American Bus
P.O. Box 127
Andover, MN 55304
763-757-7630
763-757-7632 fax
www.grandeam.com
randy@grandeam.com

Hoglund Bus
P.O. Box 249
Monticello, MN 55362
763-295-5119
763-295-4992 fax
parts@hoglundbus.com
bcparts@hoglundbus.com

Midwest Bus Co.
5234 Barthel Industrial Drive
Albertville, MN 55301
763-494-9028
763-494-9058 fax
www.midwestbus.com
abmidwest@earthlink.net

MISSISSIPPI

Empire Trucking
373 U.S. Hwy 49S
Jackson, MS 39288
601-939-5000
601-932-1570 fax

MISSOURI

Allied Bus Sales
P.O. Box 470
1101 Kenneth Street
Nixa, MO 65714-0470
417-725-2685
417-725-4853 fax
john_glove@lpsg.com

Superior Linen Supply
3001 Cherry Street
Kansas City, MO 64108
816-931-4477
816-931-0504 fax
www.superiorstyle.com
jgk@superiorlinen.net

Woodland Parts
12 North Allen
Bonne Terre, MO 63628
573-358-2299
573-358-2221 fax
www.woodlandparts.com
busgal@charter.net

Products, Inc. of Florida

NEW YORK

All Points Bus Inc.
234 North Fehr Way
North Baysshore, NY 11706
800-852-9298
631-586-9355
631-586-9356 fax
www.allpointsbus.com
parts@allpointsbus.com

Bus Parts Warehouse
1Thermold Drive
Manlius, NY 13104
800-635-5567
315-628-8834
315-682-4443 fax
www.buspartwarehouse.com
operations@buspartwarehouse.com

Gorman Bus
691 Bulis Road
Elma, NY 14059
800-462-7853
716-675-3897
716-675-1936 fax
www.gormanent.com
jfaskel@gormanent.com

New York Bus Sales
2265 Lake Port Road
Chittenango, NY 13037
315-687-3920
315-687-7746 fax
www.newyorkbussales.com
jjrichmond@newyorkbussales.com

NORTH CAROLINA

J.R. Kennedy Bus
5136 J.R.K. Drive
Durham, NC 27705
800-334-2407
919-383-8480 fax
www.kennedybus.com
info@kennedybus.com

NORTH DAKOTA

Harlow's Bus Sales
Highway 66 West
Rolette, ND 58366
800-246-3700
701-246-3560 fax
www.harlowbussales.com
parts@utma.com

OHIO

Easy Way Safety Services
10901 Reed Hartman Highway
Cincinnati, OH 45242
800-543-0575
513-891-5663 fax
www.easywaysafetyervices.com
brubin@easywaysafetyervices.com

Ohio Bus Sales
P.O. Box 6210
Canton, OH 44706
330-453-3725
330-453-8744 fax
www.obsinc.net
parts@obsinc.net

Transportation Accessories
P.O. Box 546
Johnstown, OH 43031
800-848-0756
614-855-1324 fax
www.tacbusparts.com
cgibbons@tacbusparts.com

Transportations Equipment Sales
6401 Seaman Road
Oregon, OH 43618
419-836-2835
419-836-5440 fax
www.tescobus.com
kmaunz@tescobus.com

OREGON

Schetky NW Sales
P.O. Box 20041
Portland, OR 97294
800-769-0902
503-287-5690
www.schetkynw.com
beth@schetkynw.com

Western Bus Sales
30355 SE Highway 212
Boring, OR 97009
503-905-0002
800-344-3167
503-905-0060 fax
www.westernbus.com
tmorgan@westernbus.com

SOUTH DAKOTA

Foreman Sales & Service
1602 N. Broadway
Miller, SD 57362
800-310-2708
605-853-3124 fax
foremantc@turtlecreek.net

SOUTH CAROLINA

Interstate Transportation Equipment, Inc.
2511 Trotter Road
Columbia, SC 29290
800-726-0779
803-776-5041
803-776-3527 fax

TEXAS

Blue Star Bus Sales
5907 63rd. Street
Lubbock, TX 79424
800-988-4170
806-794-5807 fax
bluebird@nts-online.net

Buck's Wheel & Equipment
220 Commercial Street
Fort Worth, TX 76107
800-792-1011
817-338-0505 fax
www.buckswheel.com
bucks_1@charterinternet.com

GTD Medical
830 S. Mason Road B1
Katy, TX 77450
281-392-5400
800-496-1966 fax

Distributors, continued

VIRGINIA

Kingmor Supply
3400 Cross Keys Road
Harrisonburg, VA 22801
800-792-4474
540-433-0099 fax
www.kingmorsupply.com
parts@kingmorsupply.com

Sonny Merryman
US Route 29 South
P.O. Box 495
Rustburg, VA 24588
434-821-1000
800-386-7278
434-821-2621 fax
www.sonnymerryman.com
angela.s@sonnymerryman.com

Virginia Truck Center
267 Lee Highway
Roanoke, VA 24019
540-777-7700
540-777-5677 fax
bdeskins@virginiatruckcenter.com

WEST VIRGINIA

Matheny Motor Truck
3rd and Ann Street
Parkersburg, WV 26102
304-485-4418
304-485-2577 fax
www.mathenymotors.com
parts@mathenymotors.com

Rehab Dimensions
411 Second Street
St. Mary's, WV 26170
304-684-9294
304-684-0014 fax
shellwv@citlink.net

WISCONSIN

Unique Vehicles
4221 Nakoosa Trail
Madison, WI 53714
800-648-1346
608-241-0000 fax
ron_uv@yahoo.com

Wisconsin Bus Sales
614 Bakke Drive
De Forest, WI 53532
608-846-2409
608-846-0905 fax
parts@wisconsinbussales.com

INTERNATIONAL

AUSTRALIA

Fas Therapeutic
3 Bradshaw Street Mordialloc
VIC 3195
Melbourne, Australia
039-587-67664
514-739-9488 fax
bs@fasequipment.com

PUERTO RICO

Camera Mundi
P.O. Box 6864
Caguas, Puerto Rico 00726
787-743-4876
787-746-4979 fax

CANADA

The Bus Boys/Perry Rand
293 Hwy 1
Cambridge, NS
Canada, BOP 1V0
902-679-7773
902-679-0659 fax
www.thebusboys.com
sandybuchan@thebusboys.com